

PRODUCT SPECIFICATIONS

Elkay Quartz Luxe® 35-7/8" x 20-15/16" x 9" Single Bowl Farmhouse Sink with Perfect Drain. Proprietary manufacturing process that combines natural quartz with high performance UV-stable acrylic resins results in an impact resistant, nonporous and heat-, scratch-, stain- and fade-resistant surface. Naturally sound deadening and Rear Center drain placement.

Installation Type:	Farmhouse
Material:	Quartz
Special Features:	Perfect Drain
Finish:	Caviar (CA), Charcoal (CH), Chestnut (CN), Jubilee (JB), Parchment (PA), Ricotta (RT), Silvermist (SM)
Number of Bowls:	1
Sink Dimensions:	35-7/8" x 20-15/16" x 10-5/16"
Bowl 1 Dimensions:	32-1/2" x 16-1" x 8-1"
Drain Size:	3-5/8" (92mm)
Drain Location:	Rear Center
Minimum Cabinet Size:	36"
Mounting Hardware:	Part # 54300408 included

Special Note: Reserve Selection products are sold exclusively, in-store and online, through authorized wholesalers.

Perfect Drain: Seamlessly molded collar eliminates the gap between a traditional drain and the sink for a sanitary and gap free installation. Select garbage disposers can be installed on either sink bowl for user convenience. Please see our Garbage Disposer Compatibility Guide.

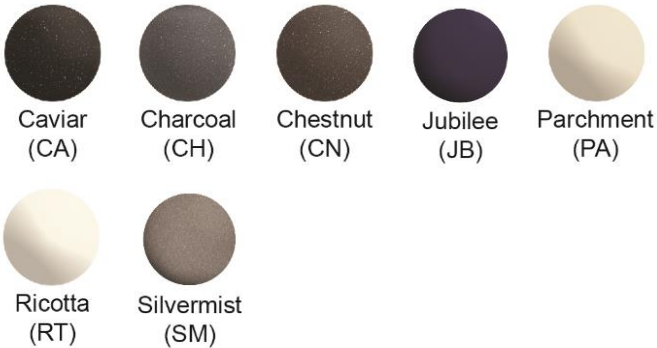

Included with Product: One LKPDQ1CR Perfect Drain and strainer.

A Century of Tradition and Quality. For more than 100 years, Elkay has been making innovative products and providing exceptional customer care. We take pride in offering plumbing products that make life easier, inspire change and leave the world a better place.

Product Compliance: CSA B45.5/IAPMO Z124
Accessory: ASME A112.18.2/CSA B125.2



Sinks are listed by IAPMO® as meeting the applicable requirements of the Uniform Plumbing Code®, International Plumbing Code®, and National Plumbing Code of Canada.

- [Clean and Care Manual \(PDF\)](#)
- [Installation Instructions \(PDF\) - 1000005326](#)
- [Installation Instructions \(PDF\) - 1000003889_perfect-drain](#)
- [Installation Instructions \(PDF\) - Garbage Disposer Compatibility Guide](#)
- [Warranty \(PDF\)](#)

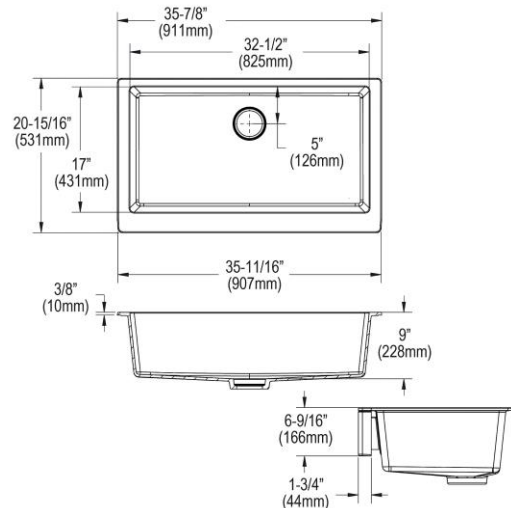

PART: _____ QTY: _____
 PROJECT: _____
 CONTACT: _____
 DATE: _____
 NOTES: _____
 APPROVAL: _____



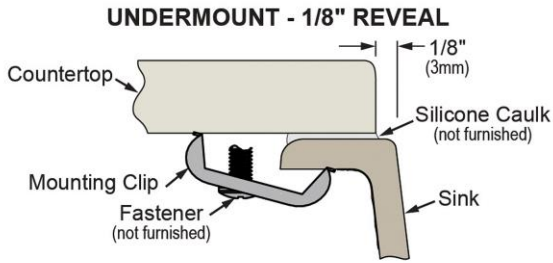

In keeping with our policy of continuing product improvement, Elkay reserves the right to change product specifications without notice. Please visit elkay.com for the most current version of Elkay product specification sheets. This specification describes an Elkay product with design, quality, and functional benefits to the user. When making a comparison of other producers' offerings, be certain these features are not overlooked.

Installation Profile:

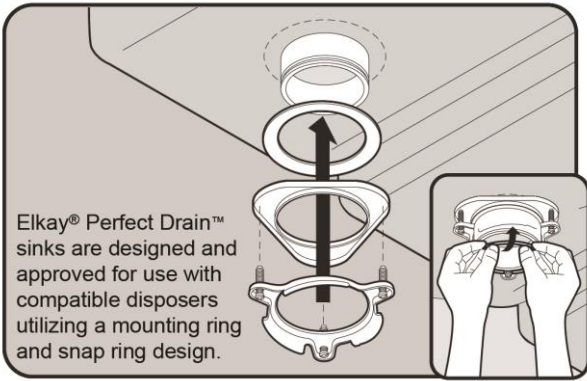
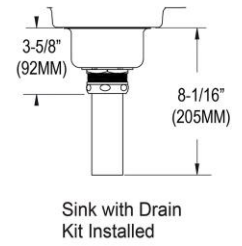
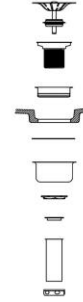

Designed to affix to the underside of any solid surface countertop.



Optional Accessories		
LKOBG3014SS	Elkay Stainless Steel 14-7/16" x 29-15/16" x 1-1/4" Bottom Grid Spec Sheet (PDF)	
LKPDQ1LS	Elkay Perfect Drain Fitting Type 304 Stainless Steel Body and Strainer Lustrous Steel Spec Sheet (PDF)	
LKEC2031	Elkay Explore Single Hole Kitchen Faucet with Pull-down Spray and Forward Only Lever Handle Spec Sheet (PDF)	
LK6000	Elkay Everyday Single Hole Deck Mount Kitchen Faucet with Pull-down Spray Forward Only Lever Handle Spec Sheet (PDF)	

In keeping with our policy of continuing product improvement, Elkay reserves the right to change product specifications without notice. Please visit elkay.com for the most current version of Elkay product specification sheets. This specification describes an Elkay product with design, quality, and functional benefits to the user. When making a comparison of other producers' offerings, be certain these features are not overlooked.